

Top View

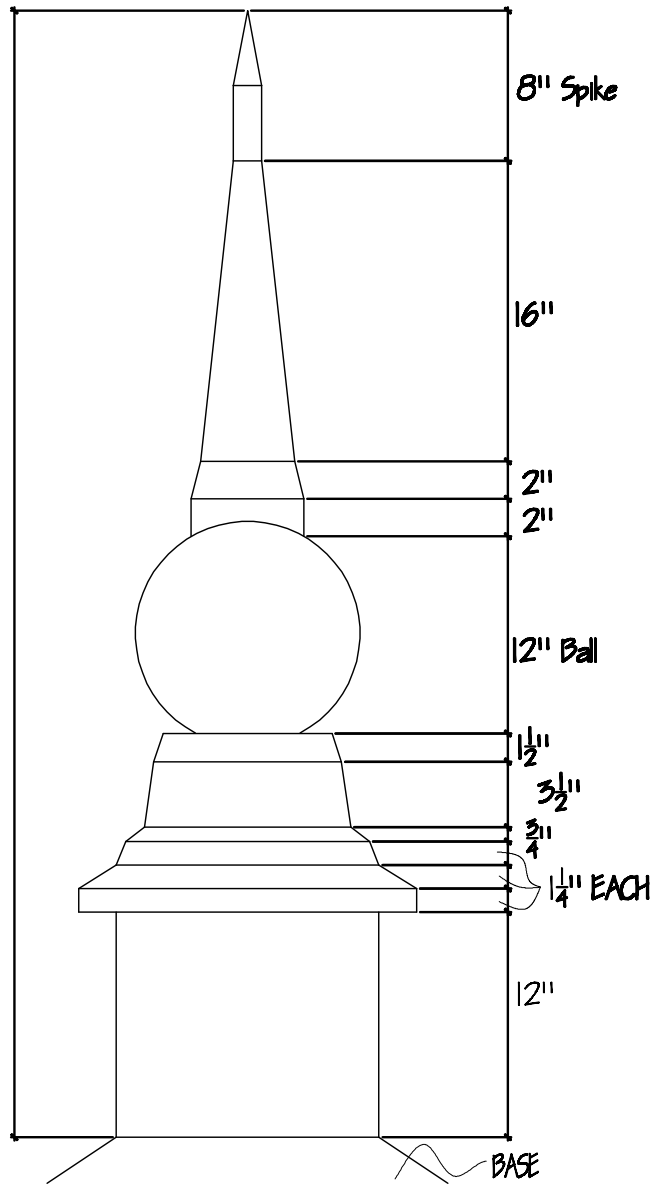
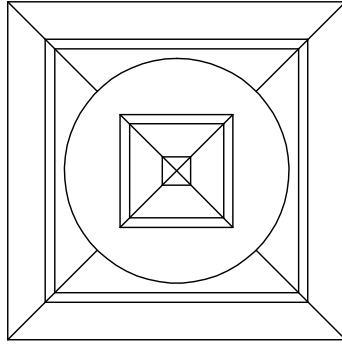

OLD WORLD DISTRIBUTORS, INC.

Part No.: Chapel 5

Available Materials:
16oz Copper
16oz Freedom Gray Copper

Notes:
Base Made to Pitch